

# WISEROL

# WISEMONT



2019

"Her zaman daha iyi"



Özgün Tasarım  
Original Design



Dokunmatik Buton  
Touch Button



Güvenli  
Safety



Performans ve Verimlilik  
Performance and Efficiency



RFID Manyetik Kart Okuyucu  
RFID Magnetic Card Reader



Cam Tasarım  
Glass Design



Güvenilirlik ve Servis  
Reliability and Service



Paslanmaz Çelik  
Stainless Steel



Engelliye Uygun  
Disabled



Sıva Üstü Montaj  
Surface Mounting



Sıva Altı Kutulu  
Boxed Assembly

# WISEROL

# İçindekiler index

KABİN BUTONYERİ CAR FIXTURES COP	SERI/SERIES	GS	4
		PG	8
		GT	10
		SG	14
		LGP	16
		DGP	18
		SGN	20
		LSP	22

KAT BUTONYERİ LANDING FIXTURES LOP	SERI/SERIES	PSX	26
		SG	30
		PG	33
		PS	36
		GS	38
		GT	40
		LS	43

KAPI ÜSTÜ GÖSTERGELER LANDING INDICATORS		44
---	--	----

KUMANDA SİSTEMLERİ CONTROL SYSTEMS	SERI/SERIES	MT70	48
		RNS	51
		MM	52

► *İnce detaylarda fark yaratan çarpıcı tasarımlar*

► *Impressive design and elegant details that make*



**WISEROL**



KABİN BUTONLARI

CAR FIXTURES

# GS Serisi Kabin Butonyeri GS Series COP



Özgün Tasarım  
Original Design



Güvenli  
Safety



Performans ve Verimlilik  
Performance and Efficiency



RFID Manyetik Kart Okuyucu  
RFID Magnetic Card Reader



Cam Tasarım  
Glass Design



Güvenilirlik ve Servis  
Reliability and Service



Sıva Altı Kutulu  
Boxed Assembly

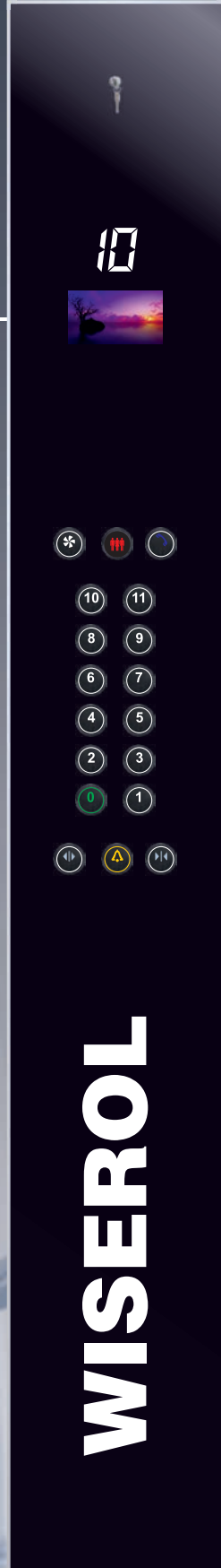

hedefinizi iyi seçin

Choose your  
destination well

# GS

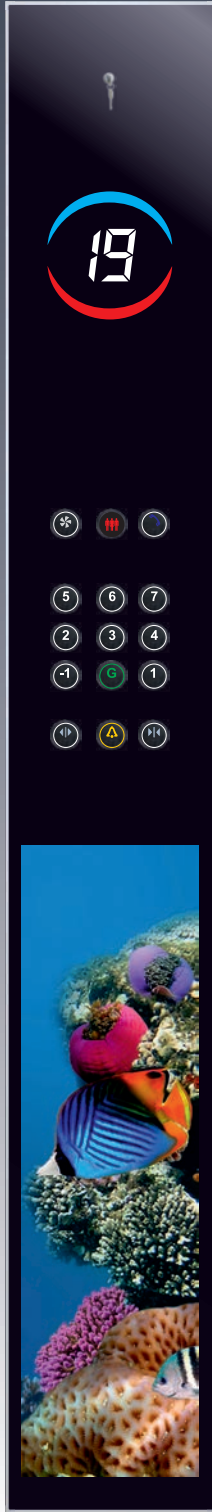

**GSN2000-D64**  
2000 x 280mm

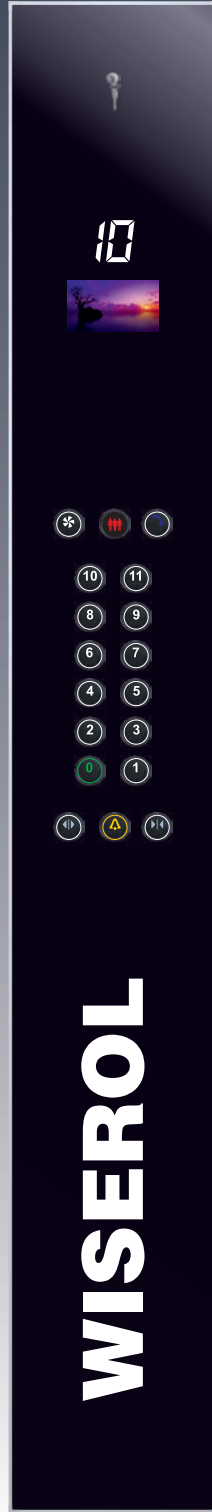

**GSN2000-DPF**  
2000 x 280mm

### OPSİYONLAR / OPTIONS



WST



SWST



RFID MANYETİK KART OKUYUCU  
RFID MAGNETIC CARD READER

### GÖSTERGE / DISPLAY



7" TFT

### VİDEO OYNATICI VIDEO PLAYER



### GSN2000 SERİSİ CAM KABİN BUTONYERİ

- 6 mm Temperli Cam
- Işıklı Çerçeve (IGSN2000)
- Siviçli Buton
- Çalışma Voltajı 24 VDC

### GSN2000 SERIES GLASS CAR OPERATIONAL PANEL

- 6 mm Tempered Glass
- Light frame (IGSN2000)
- Push Button
- Operating Voltage 24 VDC

camın  
estetik & şıklığı  
aesthetics and  
elegance of glass

GSN1000 SM  
1000 x 200 x 24mm



Özgün Tasarım  
Original Design



Güvenli  
Safety



Performans ve Verimlilik  
Performance and Efficiency



RFID Manyetik Kart Okuyucu  
RFID Magnetic Card Reader



Cam Tasarım  
Glass Design



Güvenilirlik ve Servis  
Reliability and Service



Sıva Üstü Montaj  
Surface Mounting





## Emperador Dark



GSN2000 SM  
2000 x 280mm

## Toros Siyahı

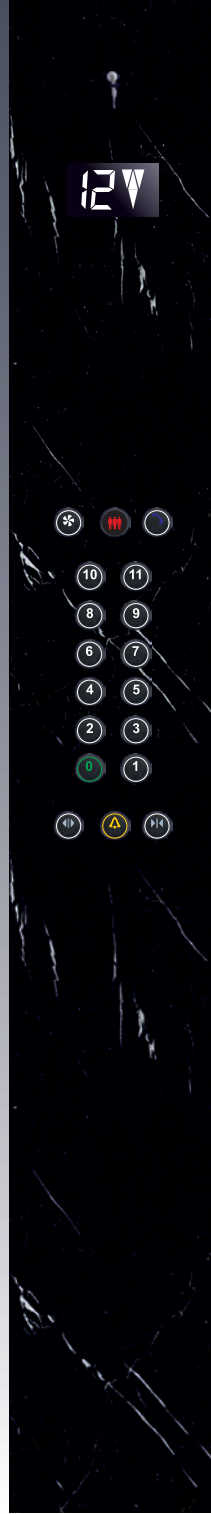

GSN2000 SM  
2000 x 280mm



Özgün Tasarım  
Original Design



Güvenli  
Safety



Performans ve Verimlilik  
Performance and Efficiency



RFID Manyetik Kart Okuyucu  
RFID Magnetic Card Reader



Cam Tasarım  
Glass Design



Güvenilirlik ve Servis  
Reliability and Service



Sıva Üstü Montaj  
Surface Mounting

## OPSİYONLAR / OPTIONS



WST



SWST



RFID MANYETİK KART OKUYUCU  
RFID MAGNETIC CARD READER

## GÖSTERGE / DISPLAY



7" TFT

VİDEO OYNATICI  
VIDEO PLAYER

## GSN1000 SERİSİ SIVA ÜSTÜ KABİN BUTONYERİ

- 4-6 mm Temperli Cam
- Siviçli Buton
- Çalışma Voltajı 24 VDC
- Sıva Üstü
- 1000x200x24 mm veya 2000x280x24 mm

## GSN1000 SERIES SURFACE MOUNT CAR OPERATIONAL PANEL

- 4-6 mm Tempered Glass
- Push Button
- Operating Voltage 24 VDC
- Surface Mount
- 1000x200x24 mm or 2000x280x24 mm

# PG Serisi Kabin Butonyeri PG Series COP



Özgün Tasarım  
Original Design



Güvenli  
Safety



Performans ve Verimlilik  
Performance and Efficiency



RFID Manyetik Kart Okuyucu  
RFID Magnetic Card Reader



Cam Tasarım  
Glass Design



Güvenilirlik ve Servis  
Reliability and Service



Paslanmaz Çelik  
Stainless Steel



Sıva Üstü Montaj  
Surface Mounting

# COP

## OPSİYONLAR / OPTIONS



WST



SWST

RFID MANYETİK KART OKUYUCU  
RFID MAGNETIC CARD READER

## GÖSTERGE / DISPLAY

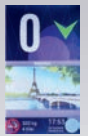

7" TFT

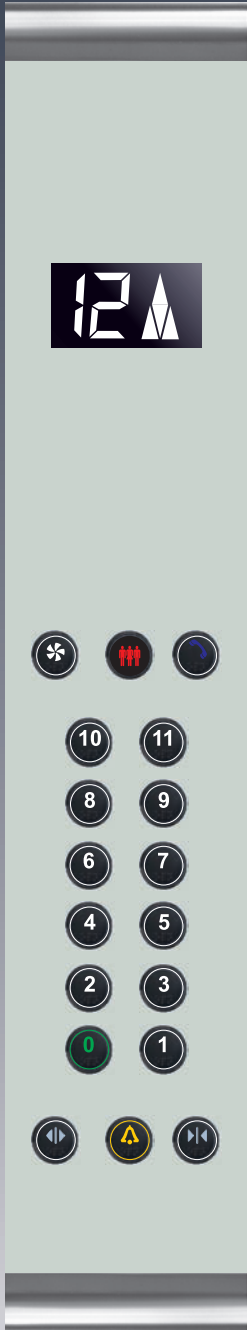
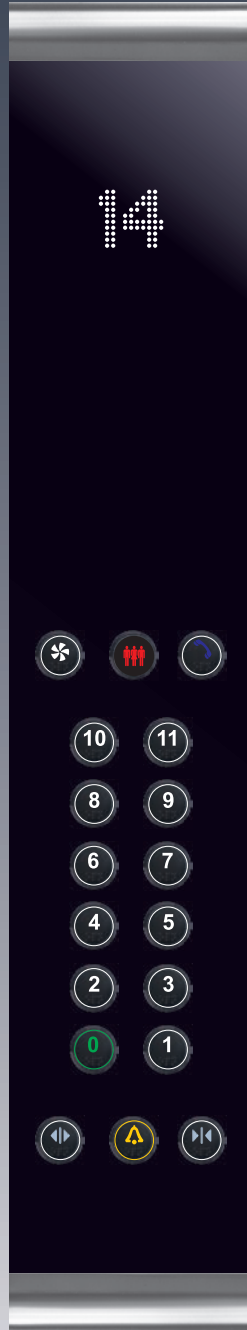
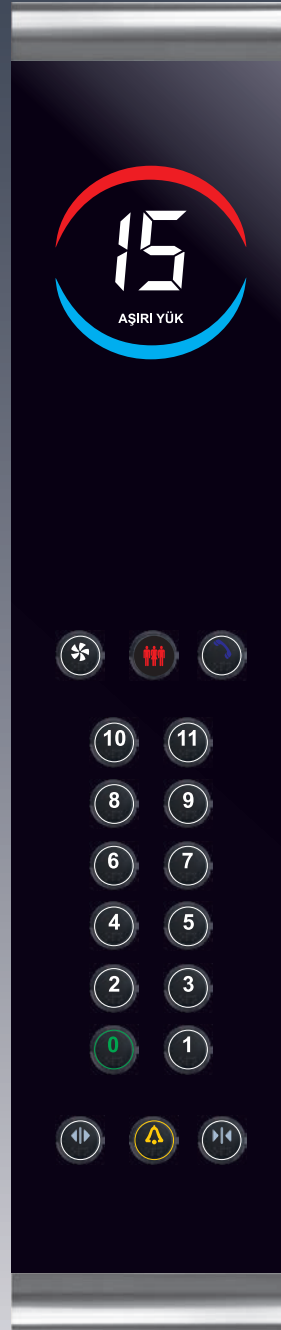
PGN1000 SM  
1100 x 200mmPGN1000 SM DM  
1100 x 200mmPGN1000 SM D64  
1100 x 230mmÖzgün Tasarım  
Original DesignPerformans ve Verimlilik  
Performance and EfficiencyPaslanmaz Çelik  
Stainless SteelGüvenli  
SafetyRFID Manyetik Kart Okuyucu  
RFID Magnetic Card ReaderCam Tasarım  
Glass DesignGüvenilirlik ve Servis  
Reliability and ServiceSıva Üstü Montaj  
Surface Mounting

## PGN1000 SM SERİSİ SIVA ÜSTÜ KABİN BUTONYERİ

- 4 mm Temperli Cam veya Akrilik
- Siviçli Buton
- Çalışma Voltajı 24 VDC
- Sıva Üstü
- 1100x200x24 mm

## PGN1000 SERIES SURFACE MOUNT CAR OPERATIONAL PANEL

- 4 mm Tempered Glass or Acrylic
- Push Button
- Operating Voltage 24 VDC
- Surface Mount
- 1100x200x24 mm

# Teknolojiyle Buluşturan Tasarım...



Dokunmatik Buton  
Touch Button

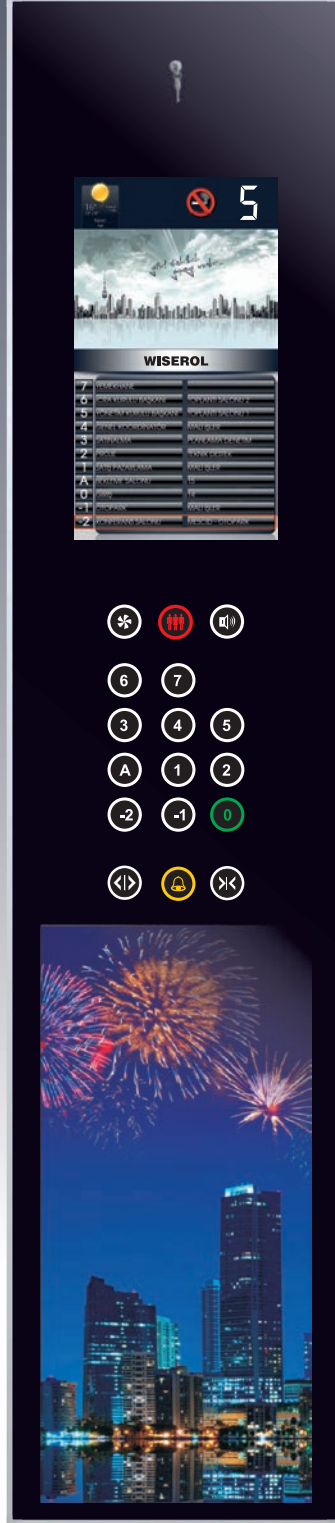

Güvenli  
Safety



Performans ve Verimlilik  
Performance and Efficiency



RFID Manyetik Kart Okuyucu  
RFID Magnetic Card Reader



Cam Tasarım  
Glass Design



Güvenilirlik ve Servis  
Reliability and Service



Paslanmaz Çelik  
Stainless Steel



Sıva Altı Kutulu  
Boxed Assembly

Design is Combining  
technology



## GT Serisi Kabin Butonyeri GT Series COP

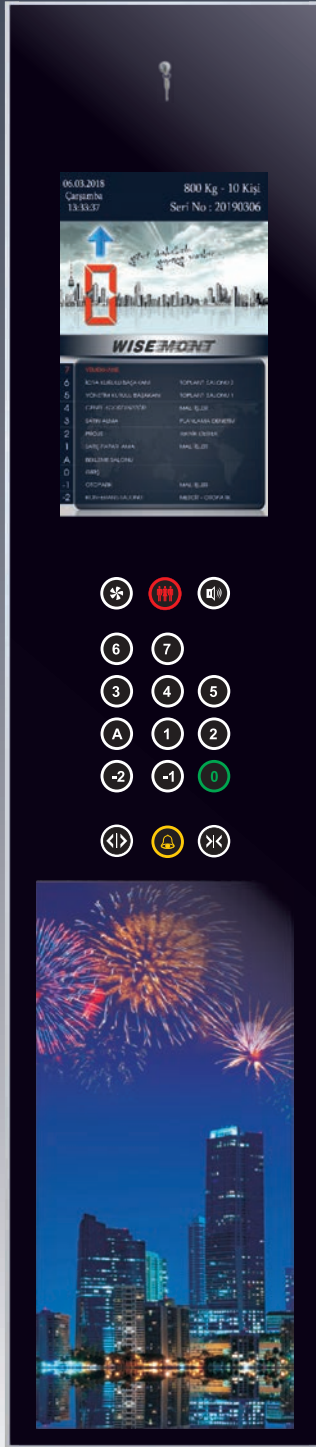

GTN2000TFT

2000 x 440mm  
(Kutu/Box : 1965 x 405 mm)

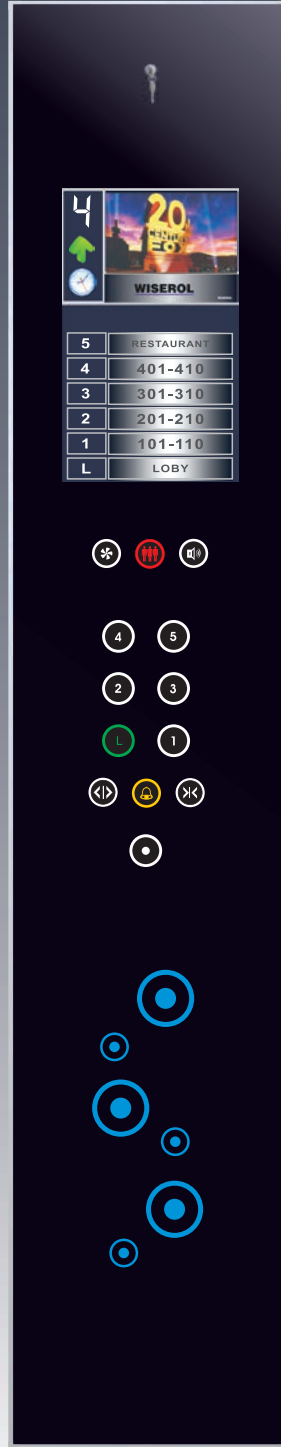

GTN2000TFT

2000 x 390mm  
(Kutu/Box : 1965 x 355 mm)



22" TFT



Özgün Tasarım  
Original Design



Dokunmatik Buton  
Touch Button



Güvenli  
Safety



Performans ve Verimlilik  
Performance and Efficiency



RFID Manyetik Kart Okuyucu  
RFID Magnetic Card Reader



Cam Tasarım  
Glass Design



Güvenilirlik ve Servis  
Reliability and Service



Sıva Altı Kutulu  
Boxed Assembly

## OPSİYONLAR / OPTIONS



RFID MANYETİK KART OKUYUCU  
RFID MAGNETIC CARD READER

## GTN-TFT SERİSİ CAM DOKUNMATİK KABİN BUTONYERİ

- 6-8 mm Temperli Cam
- Dokunmatik Buton
- Çalışma Voltajı 24 VDC
- Kapasitif Sensör Algılama
- 19" - 22" TFT Led LCD display gösterge
- Resim(JPG,BMP,TIF)-müzik(WAV,MP3,VMA)-oyunatabilme
- Video(MPG,VOB,DIVX,XVID.MP4,MKV) oynatabilme.
- Saat, tarih, kat displayi aşırı yük, yön oku, firma logosu
- Kat isimleri ve renkleri ekran üzerinden ayarlama
- Uzaktan erişim
- Bakım Zamanı için Takvim ayarlama

## GTN-TFT SERIES GLASS TOUCH CAR OPERATIONAL PANEL

- 6-8 mm Tempered Glass
- Touch Button
- Operating Voltage 24 VDC
- Capacitive Sensor Detection
- 19" - 22" TFT Led LCD Display Monitor
- Photo(jpg,bmp,tif)-music(wav,mp3,vma)- Player
- Time Floor Display Overload Direction Arrow
- Movie(MPG,VOB,DIVX,XVID.MP4, MKV) Player
- Company Name On Screen Display
- All Functions Available Program On Screen
- Remote Access
- Calendar Set for Maintenance Time

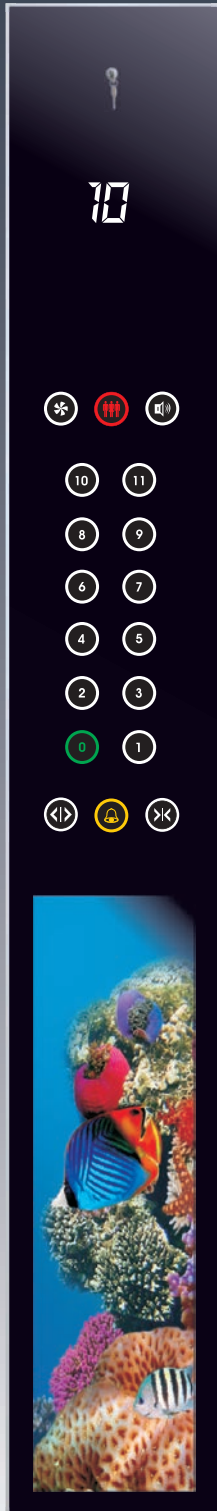
**GTN2000**

2000 x 280mm  
(Kutu/Box : 1965 x 245 mm)

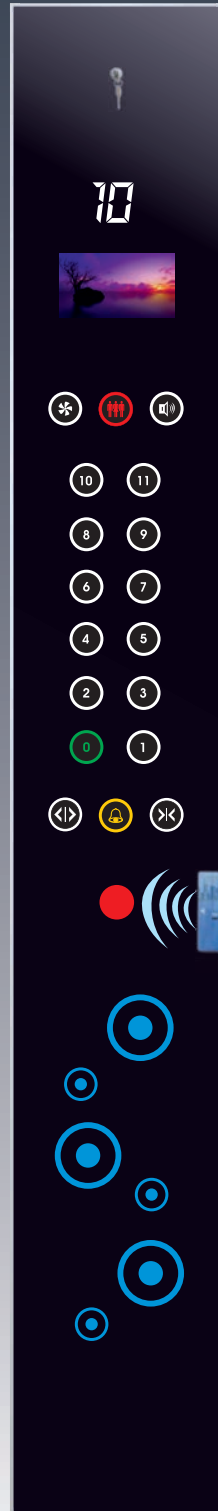
**GTN2000DPF-RFID**

2000 x 280mm  
(Kutu/Box : 1965 x 245 mm)

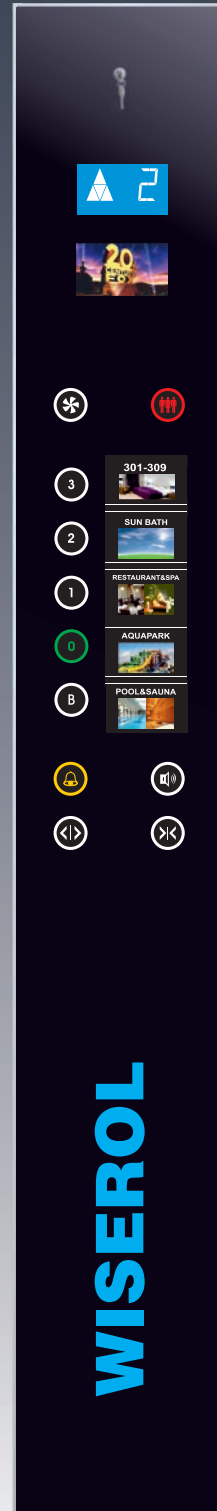
**GTN2000DPF**

2000 x 280mm  
(Kutu/Box : 1965 x 245 mm)

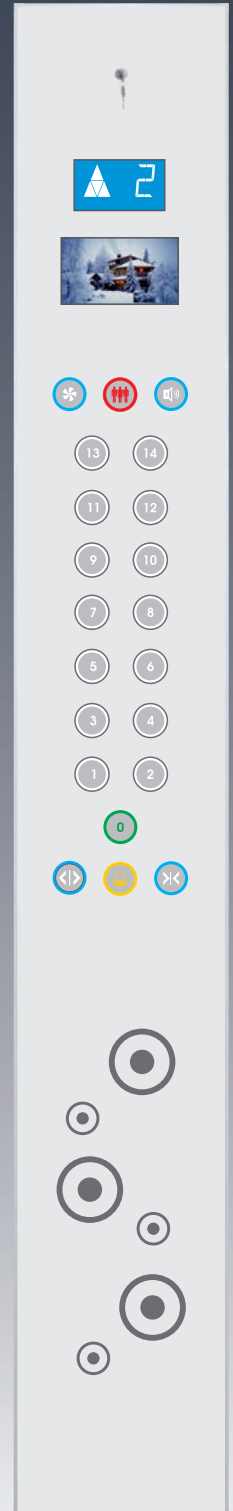
**GTN2000WDPF**

2000 x 280mm  
(Kutu/Box : 1965 x 245 mm)

**GTN SERİSİ CAM DOKUNMATİK KABİN BUTONYERİ**

- 6-8 mm Temperli Cam
- Dokunmatik Buton
- 56 mm Display gösterge (Kırmızı, Mavi, Beyaz)
- Çalışma Voltajı 24 VDC
- Kapasitif Sensör Algılama
- Opsiyonel
  - \*125 x 70 Mavi Beyaz LCD
  - \*7"-10,1" Video Oynatıcı
  - \*Işıklı Firma Logosu
  - \*RFID Manyetik Kart Okuyucu
  - \*Işıklı Çerçeve

**GTN SERIES GLASS TOUCH CAR OPERATIONAL PANEL**

- 6-8 mm Tempered Glass
- Touch Button
- 56 mm Display Indicator (Red, Blue, White)
- Operating Voltage 24 VDC
- Capacitive Sensor Detection
- Optional
  - \*125 x 70 Blue White LCD
  - \*7"-10,1" Video Player
  - \*Light Company Logo
  - \*RFID Proximity Card Reader
  - \*Light Frame

# SG Serisi Kabin Butonyeri SG Series COP



Özgün Tasarım  
Original Design



Güvenli  
Safety



Performans ve Verimlilik  
Performance and Efficiency



RFID Manyetik Kart Okuyucu  
RFID Magnetic Card Reader



Cam Tasarım  
Glass Design



Paslanmaz Çelik  
Stainless Steel



Güvenilirlik ve Servis  
Reliability and Service



Sıva Altı Kutulu  
Boxed Assembly





OPSİYONLAR / OPTIONS



**SGN2000 RFID**

2000 x 280mm  
(Kutu/Box : 1965 x 245 mm)



**SGN2000**

2000 x 280mm  
(Kutu/Box : 1965 x 245 mm)



**ISGN2000-D100**

2000 x 330mm  
(Kutu/Box : 1965 x 290 mm)



WST



SWST



SB



RFID MANYETİK KART OKUYUCU  
RFID MAGNETIC CARD READER

GÖSTERGE / DISPLAY



7" TFT

SGN SERİSİ PASLANMAZ-CAM KABİN BUTONYERİ

- 1mm paslanmaz çelik-cam kapak
- Işıklı Çerçeve (ISGN2000)
- 56mm display gösterge
- 100 mm display gösterge (Beyaz opsiyonel)
- 30mm dot matrix display gösterge (opsiyonel)
- 320x240 mavi - beyaz grafik lcd (opsiyonel)
- 125x70 Alfanumerik LCD (opsiyonel)
- Tom (touch memory) şifreleme (opsiyonel)
- Manyetik kartlı şifreleme (opsiyonel)

SGN SERIES STAINLESS-GLASS CAR OPERATIONAL PANEL

- 1mm stainless steel-glass front panel
- Light frame (ISGN2000)
- 56mm display indicator
- 100mm display indicator (White optional)
- 30mm dot matrix display indicator (optional)
- 320x240 blue - white graphic lcd (optional)
- 125x70 Alphanumeric LCD (optional)
- Tom (touch memory) startup code (optional)
- Proximity card reader startup code (optional)

# LGP Serisi Kabin Butonyeri LGP Series COP



LGN2000 SM  
2000 x 230mm

 Özgün Tasarım  
Original Design

 Güvenli  
Safety

 Paslanmaz Çelik  
Stainless Steel

 Cam Tasarım  
Glass Design

 RFID Manyetik Kart Okuyucu  
RFID Magnetic Card Reader

 Performans ve Verimlilik  
Performance and Efficiency

 Güvenilirlik ve Servis  
Reliability and Service

 Sıva Üstü Montaj  
Surface Mounting

OPSİYONLAR / OPTIONS



WST



SWST



SB



RFID MANYETİK KART OKUYUCU  
RFID MAGNETIC CARD READER

GÖSTERGE / DISPLAY

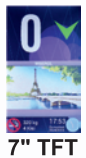

7" TFT



LGNP2000 SM  
2000 x 230mm



LGNP2000 SM  
2000 x 230mm



LGNP1000 SM  
1000 x 200mm

LGNP SERİSİ KABİN BUTONYERİ

- 1mm paslanmaz çelik ve cam kapak
- 56mm display gösterge (Mavi opsiyonel)
- 50mm 11x15 dot matrix display gösterge (opsiyonel)
- 125x70 Alfanumerik LCD (opsiyonel)
- 7" TFT Renkli LCD Ekran
- 24v led sinyal (kırmızı - yeşil - mavi)
- RFID manyetik kart şifreleme (opsiyonel)

LGNP SERIES CAR OPERATIONAL PANEL

- 1mm stainless steel and glass front panel
- 56mm display indicator(blue optional)
- 50mm 11x15 dot matrix display indicator (optional)
- 125x70 Alphanumeric LCD (optional)
- 7" TFT LCD Display
- 24v led indicator (red - green - blue colour)
- RFID magnetic card startup code (optional)

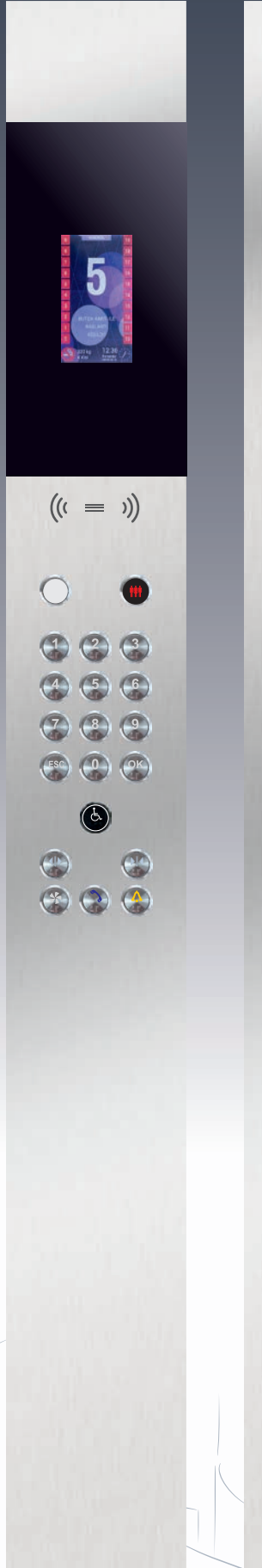

Akıllı Sistem  
Sade Arayüz

Smart System  
Simple Interface



Özgün Tasarım  
Original Design



Güvenli  
Safety



Paslanmaz Çelik  
Stainless Steel



Cam Tasarım  
Glass Design



RFID Manyetik Kart Okuyucu  
RFID Magnetic Card Reader



Performans ve Verimlilik  
Performance and Efficiency



Güvenilirlik ve Servis  
Reliability and Service



Sıva Üstü Montaj  
Surface Mounting

DGN2000 SM  
2000 x 230mm

D  
G  
D

# 48 Durağa Kadar Standart Kabin Butonu Up To 48 Stop One Style COP

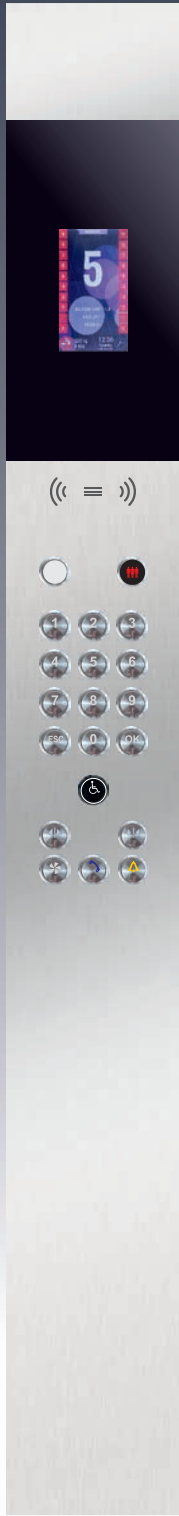

**DGNP2000 SM**  
2000 x 230mm

## GX70TFT



■ Bulunduğu Kat / Location Floor

■ Gidilen Kat / Target Floor

\* Max. 48 Kat / Max. 48 Stop

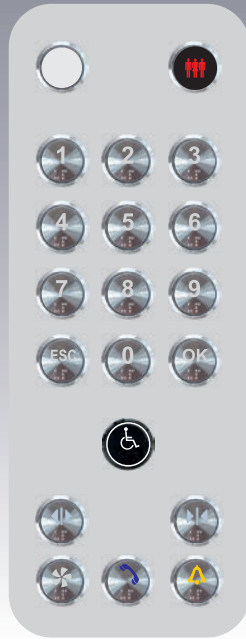

**DGNP1000 SM**  
1000 x 200mm

## OPSİYONLAR / OPTIONS



WST



SWST



SB



RFID MANYETİK KART OKUYUCU  
RFID MAGNETIC CARD READER

## Ayarlar Menüsü / Settings Menu



### DGNP SERİSİ KABİN BUTONYERİ

- 1mm paslanmaz çelik ve cam kapak
- 7" TFT Renkli Ekran
- 0...9 Tuş Takımı ile 48 Durağa Kadar Kullanım
- 24v led sinyal (kırmızı - yeşil - mavi)
- RFID manyetik kart şifreleme (opsiyonel)

### DGNP SERIES CAR OPERATIONAL PANEL

- 1mm stainless steel and glass front panel
- 7" TFT Display
- 0...9 Up to 48 Stops with Keypad
- 24v led indicator (red - green - blue colour)
- RFID magnetic card startup code (optional)

# SGN Serisi Kabin Butonyeri SGN Series COP



Özgün Tasarım  
Original Design



Güvenli  
Safety



Performans ve Verimlilik  
Performance and Efficiency



RFID Manyetik Kart Okuyucu  
RFID Magnetic Card Reader



Cam Tasarım  
Glass Design



Güvenilirlik ve Servis  
Reliability and Service



Sıva Üstü Montaj  
Surface Mounting



# SGN

## OPSİYONLAR / OPTIONS



WST



SWST



SB

RFID MANYETİK KART OKUYUCU  
RFID MAGNETIC CARD READER

## GÖSTERGE / DISPLAY

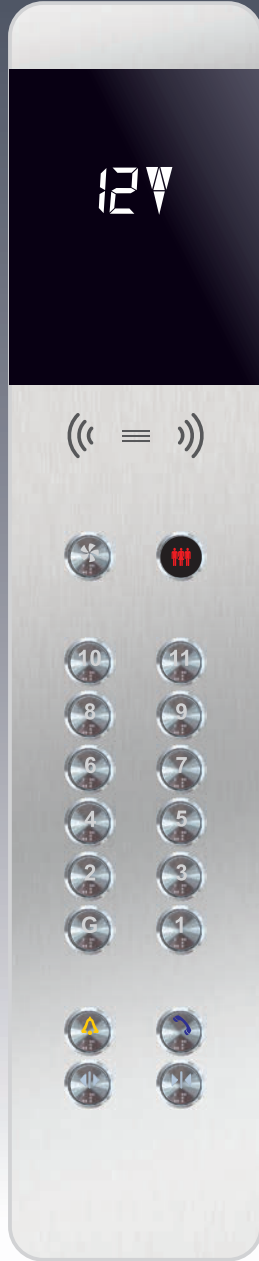
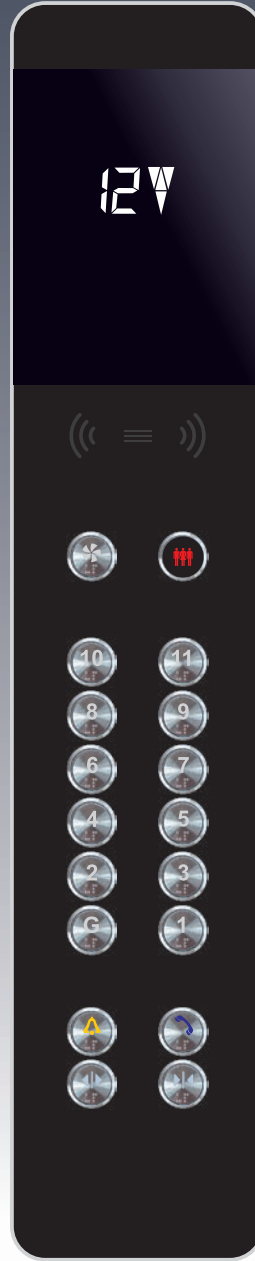

7" TFT

SGN1000 SM  
1000 x 200 x 24mmSGGN1000 SM  
1000 x 200 x 24mmSGPN1000 SM  
1000 x 200 x 24mm

## SGN SERİSİ KABİN BUTONYERİ

- 1mm paslanmaz çelik ve cam kapak (Veya Akrilik)
- 56mm display gösterge
- 50mm 11x15 dot matrix display gösterge (opsiyonel)
- 125x70 Alfanumerik LCD (opsiyonel)
- 7" TFT Renkli Ekran
- 24v led sinyal (kırmızı - yeşil - mavi)
- RFID manyetik kart şifreleme (opsiyonel)

## SGN SERIES CAR OPERATIONAL PANEL

- 1mm stainless steel and glass front panel (Or Acrylic)
- 56mm display indicator
- 50mm 11x15 dot matrix display indicator (optional)
- 125x70 Alphanumeric LCD (optional)
- 7" TFT Dipslay
- 24v led indicator (red - green - blue colour)
- RFID magnetic card startup code (optional)



EST



## LSP Serisi Kabin Butonyeri LSP Series COP

## OPSİYONLAR / OPTIONS

Özgün Tasarım  
Original DesignGüvenli  
SafetyPerformans ve Verimlilik  
Performance and EfficiencyRFID Manyetik Kart Okuyucu  
RFID Magnetic Card ReaderGüvenilirlik ve Servis  
Reliability and ServicePaslanmaz Çelik  
Stainless SteelSıva Üstü Montaj  
Surface Mounting

WST



SWST



SB

RFID MANYETİK KART OKUYUCU  
RFID MAGNETIC CARD READER

## GÖSTERGE / DISPLAY

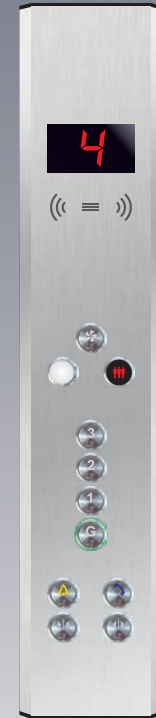
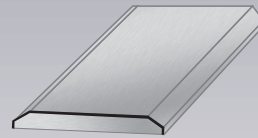
ISMN2000 SM  
2000 x 285 x 24mmLSPN2000 SM  
2000 x 237 x 24mmLSPN1000 SM  
1000 x 207 x 24mm

## LSPN SERİSİ KABİN BUTONYERİ

- 1mm paslanmaz çelik kapak
- 56mm display gösterge (Mavi opsiyonel)
- 50mm 11x15 dot matrix display gösterge (opsiyonel)
- 125x70 Alfanumerik LCD (opsiyonel)
- 24v led sinyal (kırmızı - yeşil - mavi)
- RFID manyetik kart şifreleme (opsiyonel)

## LSPN SERIES CAR OPERATIONAL PANEL

- 1mm stainless steel front panel
- 56mm display indicator (blue optional)
- 50mm 11x15 dot matrix display indicator (optional)
- 125x70 Alphanumeric LCD (optional)
- 24v led indicator (red - green - blue colour)
- RFID magnetic card startup code (optional)

## LS Serisi Kabin Butonyeri LS Series COP



**LSGPN2000**  
2000 x 230mm  
(Kutu/Box : 1900 x 190 mm)

**LSPN2000 CLCD**  
2000 x 230mm  
(Kutu/Box : 1900 x 190 mm)

**LSPN2000**  
2000 x 230mm  
(Kutu/Box : 1900 x 190 mm)

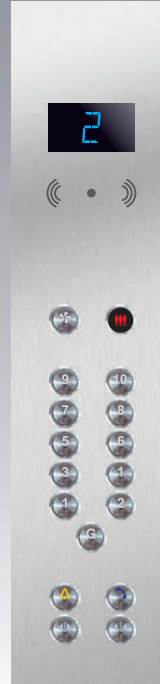

**LSPN1000**  
1000 x 230mm  
(Kutu/Box : 900 x 190 mm)

-  Özgün Tasarım  
Original Design
-  Güvenli  
Safety
-  Performans ve Verimlilik  
Performance and Efficiency
-  RFID Manyetik Kart Okuyucu  
RFID Magnetic Card Reader
-  Paslanmaz Çelik  
Stainless Steel
-  Cam Tasarım  
Glass Design
-  Güvenilirlik ve Servis  
Reliability and Service
-  Sıva Altı Kutulu  
Boxed Assembly

## OPSİYONLAR / OPTIONS



WST



SWST



SB



RFID MANYETİK KART OKUYUCU  
RFID MAGNETIC CARD READER

## GÖSTERGE / DISPLAY

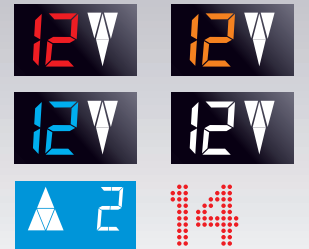

## LSPN SERİSİ KABİN BUTONYERİ

- 2mm paslanmaz çelik kapak
- 56mm display gösterge (Mavi opsiyonel)
- 50mm dot matrix display gösterge (opsiyonel)
- 125x70 Alfanumerik LCD (opsiyonel)
- 24v led sinyal (kırmızı - yeşil - mavi)
- RFID Manyetik kartlı şifreleme (opsiyonel)

## LSPN SERIES CAR OPERATIONAL PANEL

- 2mm stainless steel front panel
- 56mm display indicator(blue optional)
- 50mm dot matrix display indicator (optional)
- 125x70 Alphanumerik LCD (optional)
- 24v led indicator (red - green - blue colour)
- RFID Proximity card reader startup code (optional)

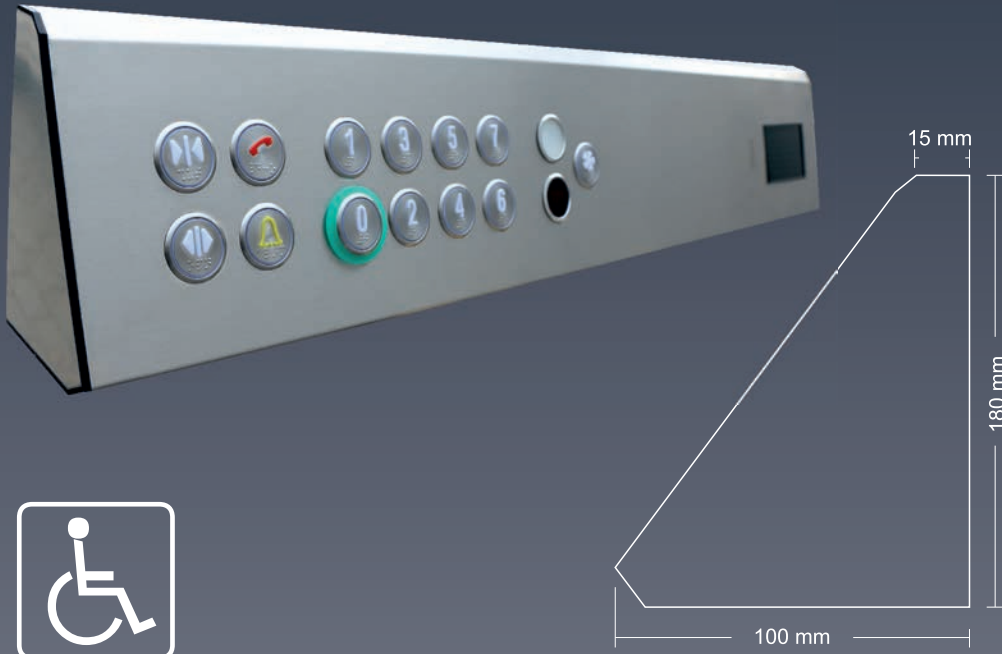

Özgün Tasarım  
Original Design



RFID Manyetik Kart Okuyucu  
RFID Magnetic Card Reader



Paslanmaz Çelik  
Stainless Steel



Güvenli  
Safety



Performans ve Verimlilik  
Performance and Efficiency



Sıva Üstü Montaj  
Surface Mounting



Engelliye Uygun  
Disabled



Güvenilirlik ve Servis  
Reliability and Service



LSPNY1000 RFID 1000 x 180 x 24 mm



LSPNY1000 1000 x 180 x 24 mm



GSNY1000 1000 x 160 x 24 mm

4mm Cam / Glass

## OPSİYONLAR / OPTIONS



WST



SWST



SB



RFID MANYETİK KART OKUYUCU  
RFID MAGNETIC CARD READER

## GÖSTERGE / DISPLAY



## LSPNY SERİSİ YATAY KABİN BUTONYERİ

- 1mm paslanmaz çelik kapak
- 56mm display gösterge
- 50mm dot matrix display gösterge (opsiyonel)
- 125x70 Alfanumerik LCD (opsiyonel)
- 24v led sinyal (kırmızı - yeşil - mavi)
- RFID Manyetik kartlı şifreleme (opsiyonel)

## LSPNY SERIES HORIZONTAL CAR OPERATIONAL PANEL

- 1mm stainless steel front panel
- 56mm display indicator
- 50mm dot matrix display indicator (optional)
- 125x70 Alphanumeric LCD (optional)
- 24v led indicator (red - green - blue colour)
- RFID Proximity card reader startup code (optional)

LANDING  
OPERATIONAL PANEL

KAT  
BUTONYERLERI



## PSX Serisi Kat Butonyeri PSX Series LOP



# PSX



PSXT251



Özgün Tasarım  
Original Design



Güvenli  
Safety



Performans ve Verimlilik  
Performance and Efficiency



Güvenilirlik ve Servis  
Reliability and Service



Paslanmaz Çelik  
Stainless Steel



Sıva Üstü Montaj  
Surface Mounting



PSXT251



PSXT252



PSXT251



PSXT252

85 mm

250 mm



PSXT251 DM



PSXT252



PSXT251



PSXT251



PSXT251 DM



PSXTB251



PSXTB252



PSXTB251



PSXTB252



PSXTB171  
170 x 85 x 12mm



PSXTB172  
170 x 85 x 12mm

### PSX SERİSİ SIVA ÜSTÜ KAT BUTONYERİ

- 0,8 mm paslanmaz çelik kapak ve kasa
- 33mm 7 segment display gösterge
- 48mm 10x11 dotmatrix display
- 24v led sinyal (kırmızı - yeşil - mavi)
- Kalınlık 13,9 mm
- Can-Bus Seri Haberleşme

### PSX SERIES SURFACE MOUNT LANDING OPERATIONAL PANEL

- 0,8 mm stainless steel frontpanel and box
- 33mm 7 segment display indicator
- 48mm 10x11 dotmatrix display
- 24v led indicator (red - green - blue colour)
- Thickness 13,9 mm
- Can-Bus Serial Communication

OPSIYONLAR / OPTIONS



WST



SWST



SB

GÖSTERGE / DISPLAY



LCD



DOTMATRIX



DISPLEY

DOTMATRIX ve DISPLEY RENKLERİ  
DOTMATRIX & DISPLAY COLOURS



PSXT2522

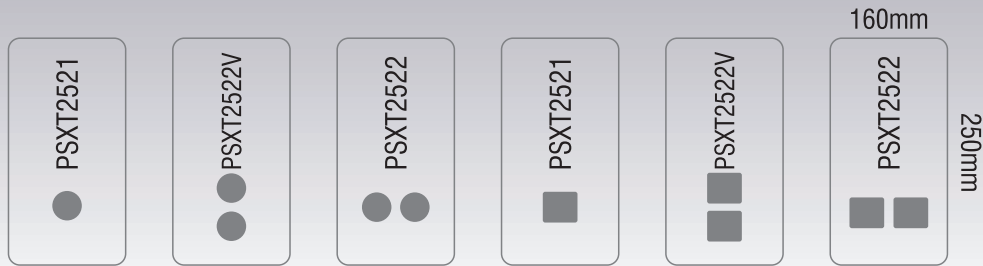

PSXT2521



PSXT2522V



PSXT2522



PSXT2521

# SG Serisi Kat Butonyeri SG Series LOP

Estetik  
ve işlevsellik  
birarada

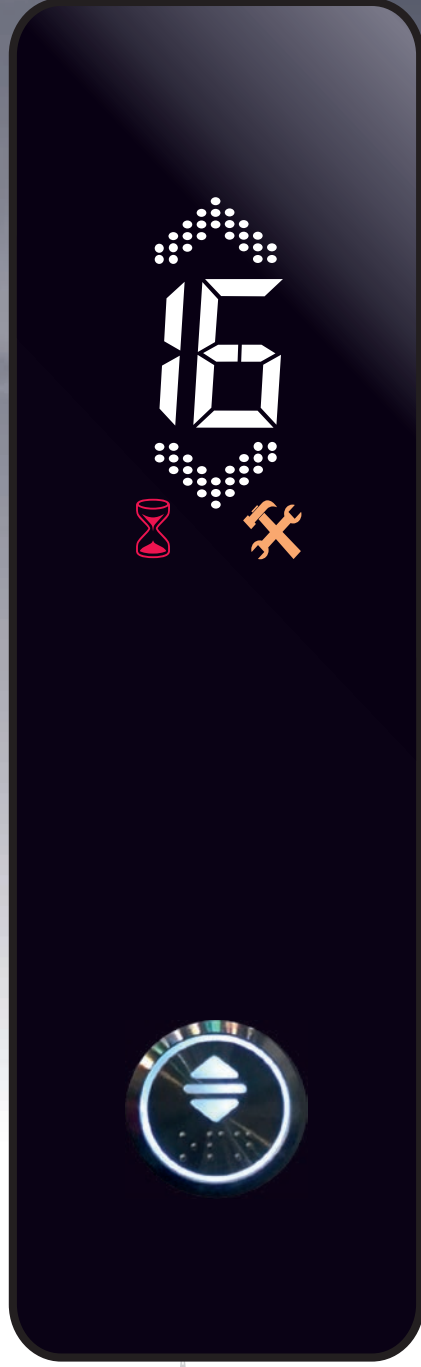

Aesthetic  
and functionality  
together



Özgün Tasarım  
Original Design



Güvenli  
Safety



Performans ve Verimlilik  
Performance and Efficiency



Cam Tasarım  
Glass Design



Güvenilirlik ve Servis  
Reliability and Service



Paslanmaz Çelik  
Stainless Steel



Sıva Üstü Montaj  
Surface Mounting

SG





SGT322  
300 x 155mm

OPSIYONLAR / OPTIONS



WST



SWST



SB

GÖSTERGE / DISPLAY



LCD



DOTMATRIX



DISPLAY

DOTMATRIX ve DISPLAY RENKLERİ  
DOTMATRIX & DISPLAY COLOURS



SGT301  
300 x 94mm

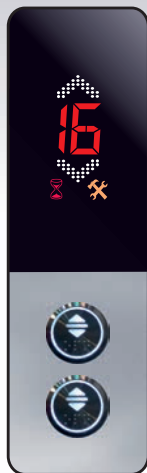

SGT302  
300 x 94mm



SGTP302  
300 x 94mm

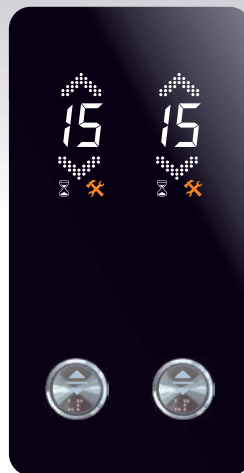

SGTP322  
300 x 155mm

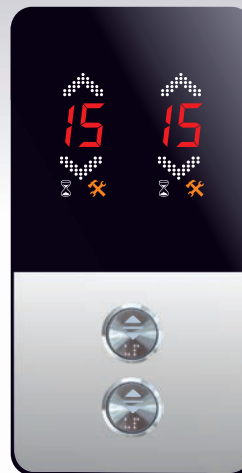

SGT322V  
300 x 155mm



SGT321  
300 x 155mm

SG SERİSİ SIVA ÜSTÜ KAT BUTONYERİ

- 2 mm paslanmaz çelik ve akrilik kapak
- 32mm display gösterge
- 48mm 10x11 dotmatrix display
- 24v led sinyal (kırmızı - yeşil - mavi)
- Kalınlık 12,9 mm
- Seri Haberleşme

SG SERIES SURFACE MOUNT LANDING OPERATIONAL PANEL

- 2 mm stainless steel and acrylic frontpanel
- 32mm display indicator
- 48mm 10x11 dotmatrix display
- 24v led indicator (red - green - blue colour)
- Thickness 12,9 mm
- Serial Communication



G





G

MISEDOI



REG

## PG Serisi Kat Butonyeri PG Series LOP



Özgün Tasarım  
Original Design



Güvenli  
Safety



Performans ve Verimlilik  
Performance and Efficiency



Cam Tasarım  
Glass Design



Güvenilirlik ve Servis  
Reliability and Service



Paslanmaz Çelik  
Stainless Steel



Sıva Üstü Montaj  
Surface Mounting



sınırları zorlayan yenilikçi  
pushing the boundaries of innovative

PG

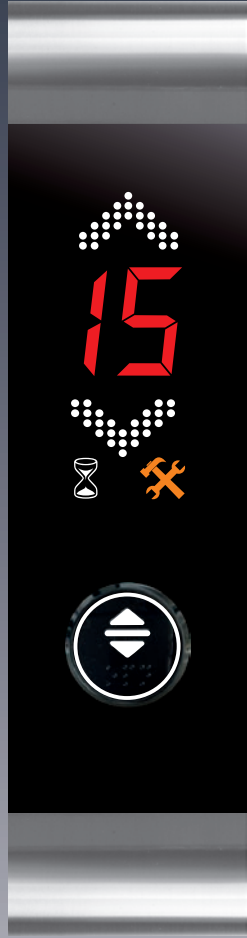

PGT281  
280 x 76mm

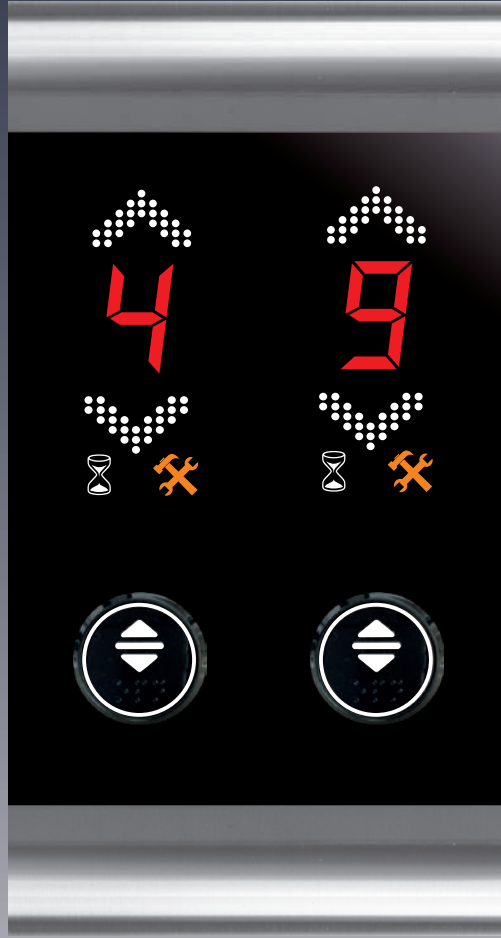

PGT2822  
280 x 150mm



PGT281



PGT281



PGT2821



PGT2822



PGT2821



PGT2822



PGT281  
280 x 76mm



PGT281 DM  
280 x 76mm



PGTB282  
280 x 76mm



PGTB281  
280 x 76mm

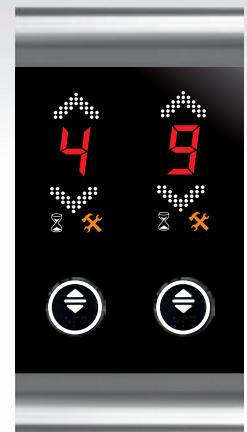

PGT2822  
280 x 150mm

OPSIYONLAR / OPTIONS



WST



SWST



SB

GÖSTERGE / DISPLAY



LCD



DOTMATRIX



DISPLAY

DOTMATRIX ve DISPLAY RENKLERİ  
DOTMATRIX & DISPLAY COLOURS



PG SERİSİ SIVA ÜSTÜ KAT BUTONYERİ

- 1mm paslanmaz çelik ve 4mm akrilik
- 32mm display gösterge
- 24v led sinyal (kırmızı - yeşil - mavi)
- 48mm 10x11 dotmatrix display

PG SERIES SURFACE MOUNT LANDING OPERATIONAL PANEL

- 1mm stainless steel and 4mm acrylic
- 32mm display indicator
- 24v led indicator (red - green - blue colour)
- 48mm 10x11 dotmatrix display

# PS Serisi Kat Butonyeri PS Series LOP



Özgün Tasarım  
Original Design



Güvenli  
Safety



Performans ve Verimlilik  
Performance and Efficiency



Cam Tasarım  
Glass Design



Güvenilirlik ve Servis  
Reliability and Service



Paslanmaz Çelik  
Stainless Steel



Sıva Üstü Montaj  
Surface Mounting



# SA

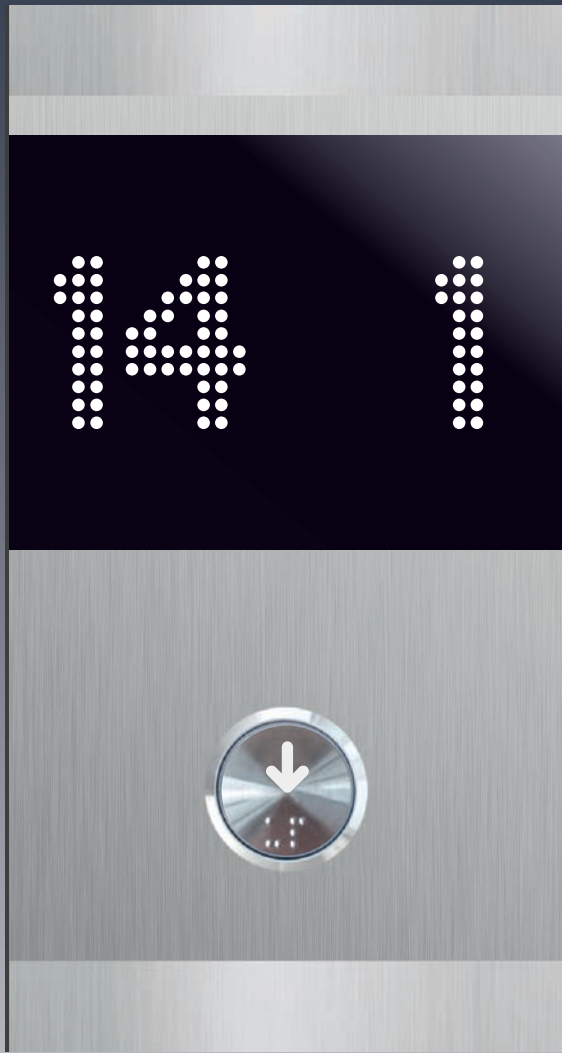

PST2821  
280 x 155mm

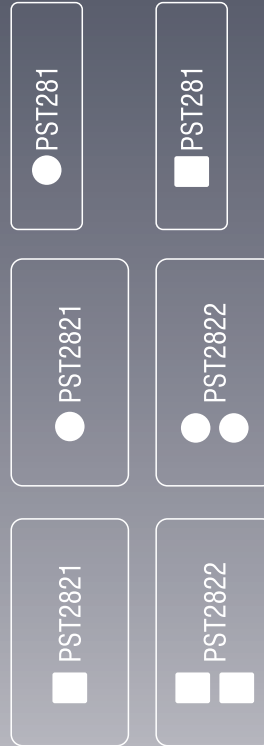

OPSIYONLAR / OPTIONS



WST



SWST



SB

GÖSTERGE / DISPLAY



LCD



DOTMATRIX



DISPLAY

DOTMATRIX ve DISPLAY RENKLERİ  
DOTMATRIX & DISPLAY COLOURS

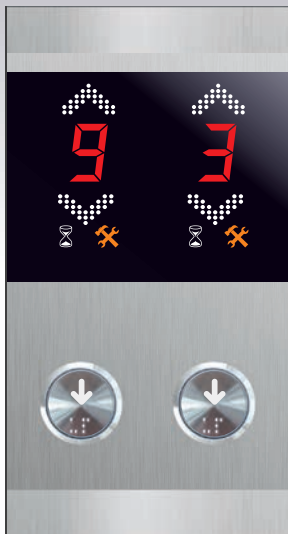

PST2822  
280 x 155mm

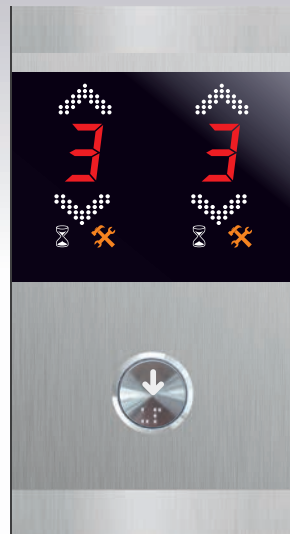

PST2821  
280 x 155mm



PST281  
280 x 84mm



PST281 DM  
280 x 84mm



PSTB282  
280 x 70mm



PSTB281  
280 x 70mm

PS SERİSİ SIVA ÜSTÜ KAT BUTONYERİ

- 1mm paslanmaz çelik
- 32mm display gösterge
- 24v led sinyal (kırmızı - yeşil - mavi)
- 48mm 10x11 dotmatrix display

PS SERIES SURFACE MOUNT LANDING OPERATIONAL PANEL

- 1mm stainless steel
- 32mm display indicator
- 24v led indicator (red - green - blue colour)
- 48mm 10x11 dotmatrix display

# GS Serisi Cam Kat Butonyeri GS Series Glass LOP



Özgün Tasarım  
Original Design



Güvenli  
Safety



Performans ve Verimlilik  
Performance and Efficiency



Cam Tasarım  
Glass Design



Güvenilirlik ve Servis  
Reliability and Service



Sıva Altı Kutulu  
Boxed Assembly

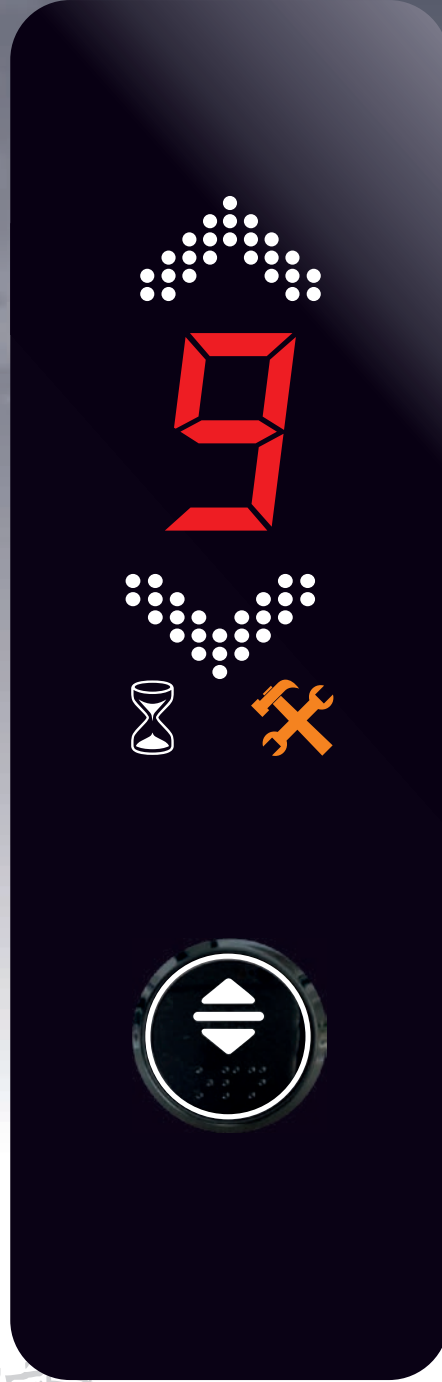

# GS



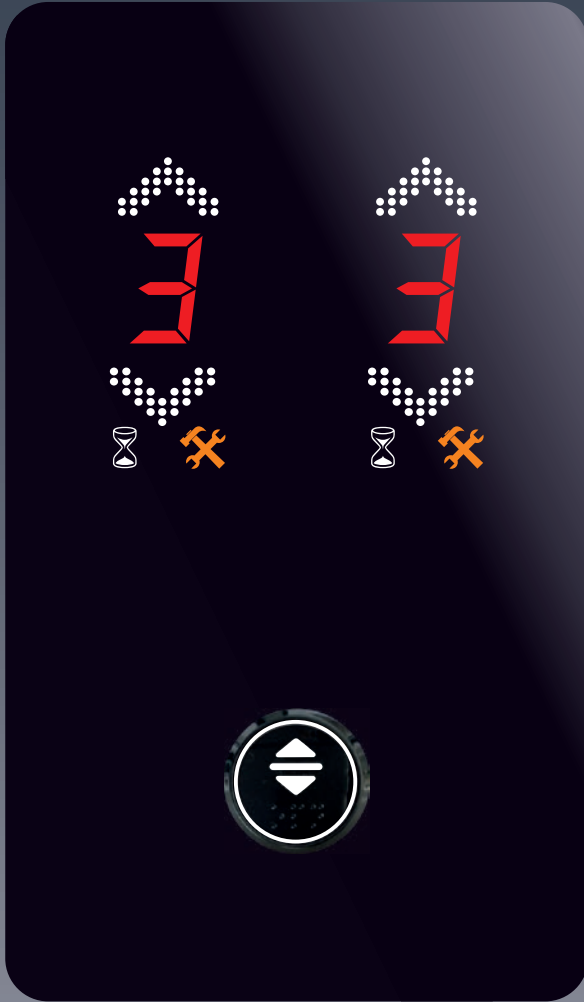

**GST321**  
300 x 155mm

OPSİYONLAR / OPTIONS



WST



SWST

GÖSTERGE / DISPLAY



LCD



DOTMATRIX



DISPLAY

DOTMATRIX ve DISPLAY RENKLERİ  
DOTMATRIX & DISPLAY COLOURS

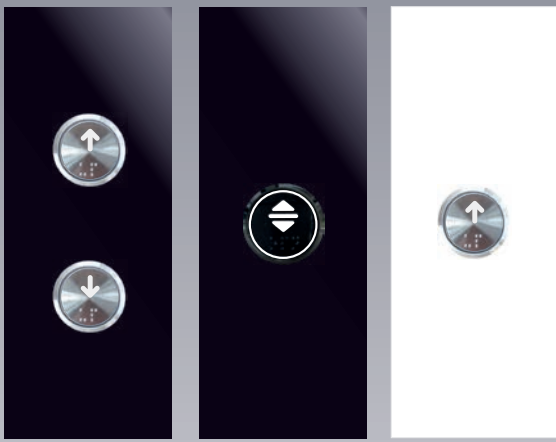
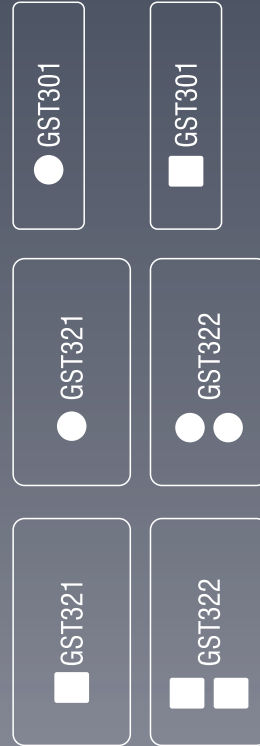

**GSTB252**  
250 x 100mm

**GSTB251**  
250 x 100mm

**GSTB251**  
250 x 100mm



**GST301**  
300 x 94mm

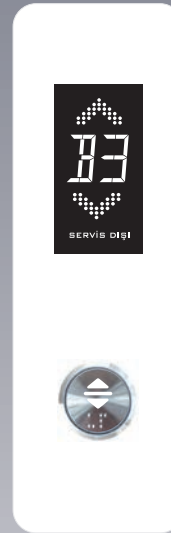

**GST301-LCD**  
300 x 94mm

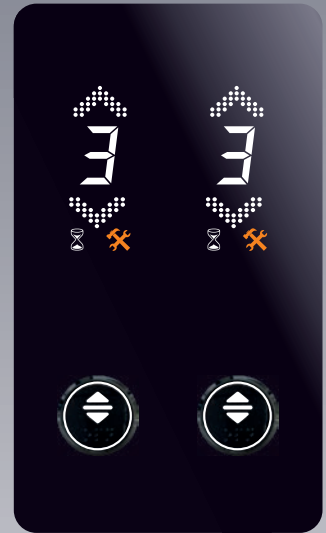

**GST322**  
300 x 155mm

GST SERİSİ CAM KAT BUTONYERİ

- 4 mm Temperli Cam
- Siviç Buton
- 25 mm Display gösterge (Kırmızı, Mavi, Beyaz)
- Çalışma Voltajı 24 VDC
- 90 x 45 mm LCD (opsiyonel)
- 48mm 10x11 dotmatrix display
- Seri Haberleşme

GST SERIES GLASS LANDING OPERATIONAL PANEL

- 4 mm Temper Glass
- Push Button
- 25 mm Display Indicator (Red, Blue, White)
- Operating Voltage 24 VDC
- 90 x 45 mm LCD (optional)
- 48mm 10x11 dotmatrix display
- Serial Communication

# GT Serisi Cam Kat Butonyeri GT Series Glass LOP



Özgün Tasarım  
Original Design



Güvenli  
Safety



Performans ve Verimlilik  
Performance and Efficiency



Sıva Altı Kurulum  
Glass Assembly



Güvenilirlik ve Servis  
Reliability and Service



Sıva Altı Kutulu  
Boxed Assembly

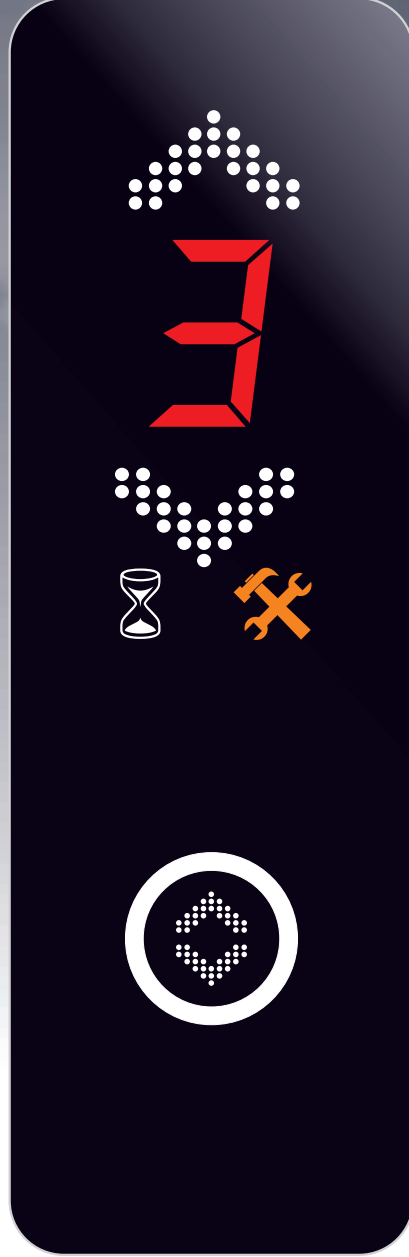

Dokunmatik Buton  
Touch Button

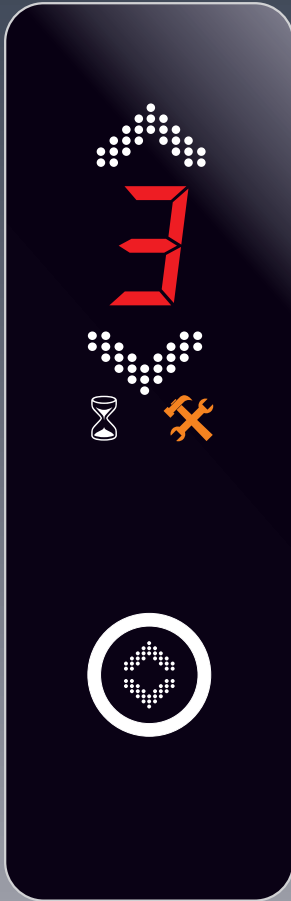

GTT301

300 x 94mm

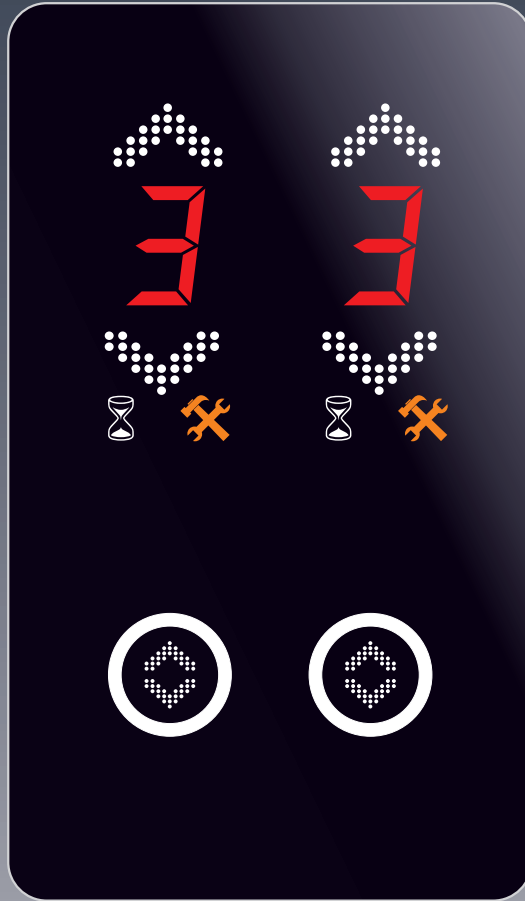

GTT321W

300 x 155mm

## OPSİYONLAR / OPTIONS

## GÖSTERGE / DISPLAY



LCD

DOTMATRIX

DISPLAY

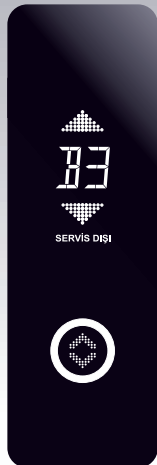
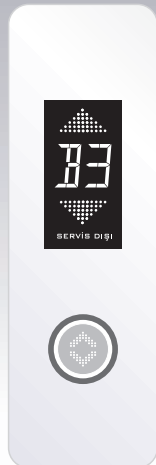
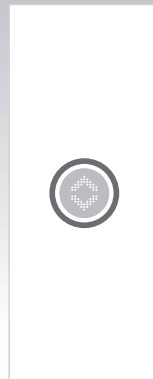
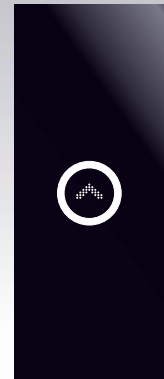
DOTMATRIX ve DISPLAY RENKLERİ  
DOTMATRIX & DISPLAY COLOURSGTT301-LCD  
300 x 94mmGTT301-LCD  
300 x 94mmGTTB251  
250 x 100mmGTTB252  
250 x 100mmGTTB251  
250 x 100mm

## GTT SERİSİ CAM KAT BUTONYERİ

- 4 mm Temperli Cam
- Dokunmatik Buton
- 25 mm Display gösterge (Kırmızı, Mavi, Beyaz)
- Çalışma Voltajı 24 VDC
- 90 x 45 mm LCD (opsiyonel)
- 48mm 10x11 dotmatrix display
- Seri Haberleşme

## GTT SERIES GLASS LANDING OPERATIONAL PANEL

- 4 mm Temper Glass
- Touch Button
- 25 mm Display Indicator (Red, Blue, White)
- Operating Voltage 24 VDC
- 90 x 45 mm LCD (optional)
- 48mm 10x11 dotmatrix display
- Serial Communication

hep birlikte  
daha ykseklerle  
all together higher

# LS Serisi Kat Butonyeri LS Series LOP



**LST281**  
280 x 90mm

**LSTW351**  
360 x 100mm

**LSTW351-LCD**  
360 x 100mm

**LSTW322**  
360 x 175mm



**LSPI350** (Kutu/Box 330x80 mm)  
360 x 100mm



**LSTB201**  
200 x 100mm

**LSTB202**  
200 x 100mm

**LST201**  
200 x 100mm



**LST361-LCD**  
360 x 100mm

**LST361**  
360 x 100mm

**LST362**  
360 x 100mm

**LST322**  
360 x 100mm

## OPSIYONLAR / OPTIONS



WST



SWST



SB

## GÖSTERGE / DISPLAY



LCD

DOTMATRIX

DISPLAY

DOTMATRIX ve DISPLAY RENKLERİ  
DOTMATRIX & DISPLAY COLOURS



Özgün Tasarım  
Original Design



Güvenli  
Safety



Performans ve Verimlilik  
Performance and Efficiency



Güvenilirlik ve Servis  
Reliability and Service



Paslanmaz Çelik  
Stainless Steel



Siva Altı Kutulu  
Boxed Assembly

## LS SERİSİ KAT BUTONYERİ

- 2mm paslanmaz çelik kapak
- 25mm display gösterge
- 18mm dot matrix display gösterge (opsiyonel)
- 24v led sinyal (kırmızı - yeşil - mavi)
- 90x45 mavi-beyaz lcd (opsiyonel)

## LS SERIES FLOOR LANDING OPERATIONAL PANEL

- 2mm stainless steel frontpanel
- 25mm display indicator
- 18mm dot matrix display indicator (optional)
- 24v led indicator (red - green - blue colour)
- 90x45 blue-white lcd (optional)



LANDING  
INDICATORS

KAPI ÜSTÜ  
KAT GÖSTERGELERİ





AGI64  
Ø 465 mm



GI130  
Ø 465 mm



GI100  
Ø 320 mm

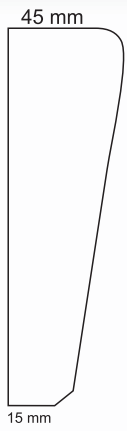

GIA250  
250 x 130mm



GIA250  
250 x 130mm

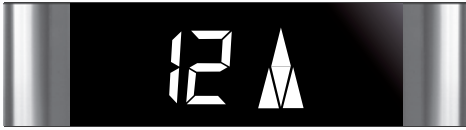

PGI280  
250 x 40 x 15mm



PGI280 DM  
250 x 40 x 15mm



PXIA250  
250 x 40 x 15mm



PXIA250  
250 x 40 x 15mm

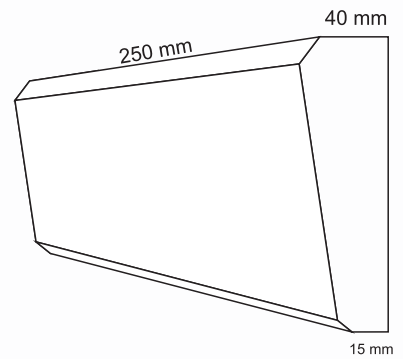

# WISER

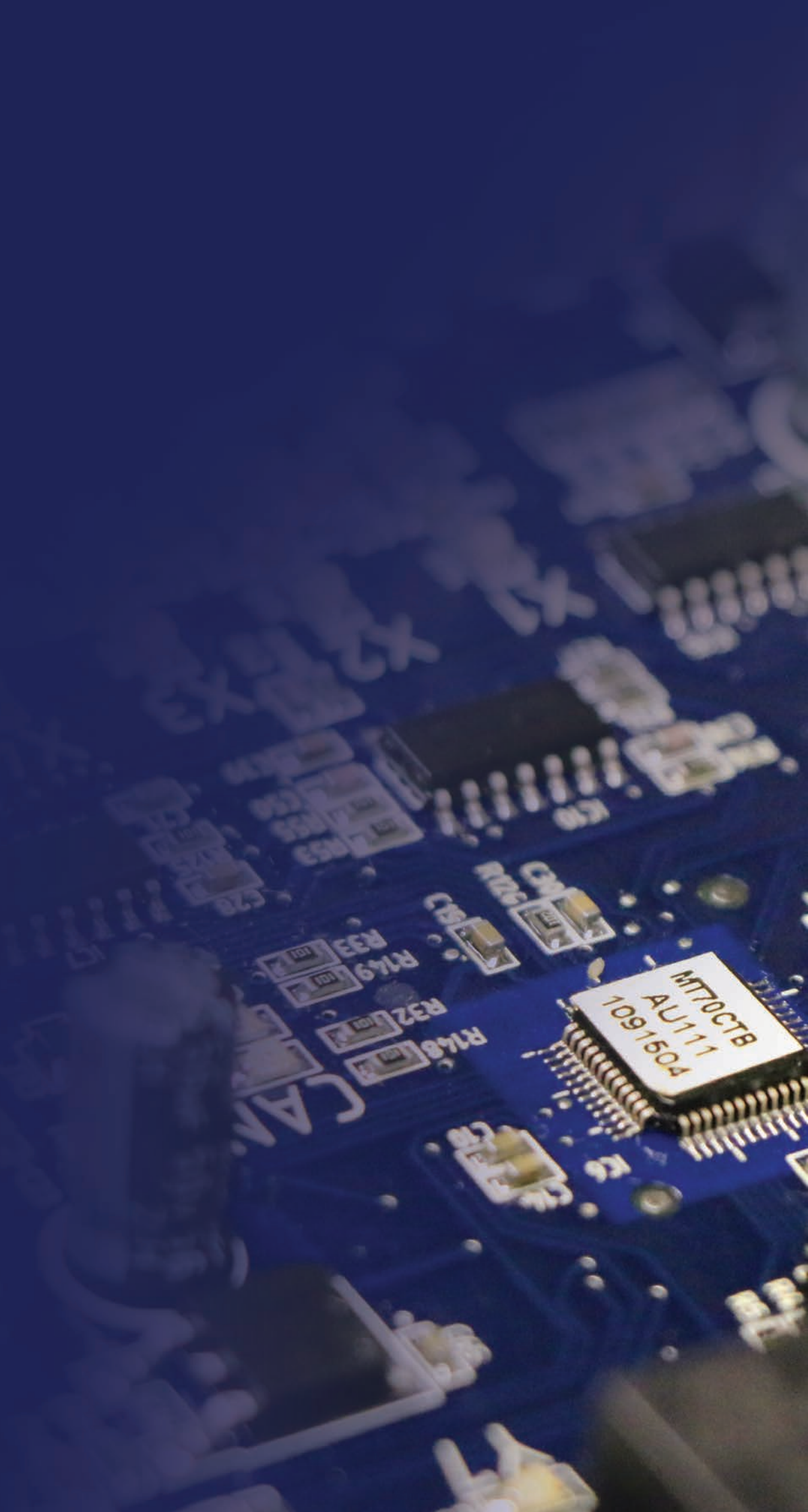



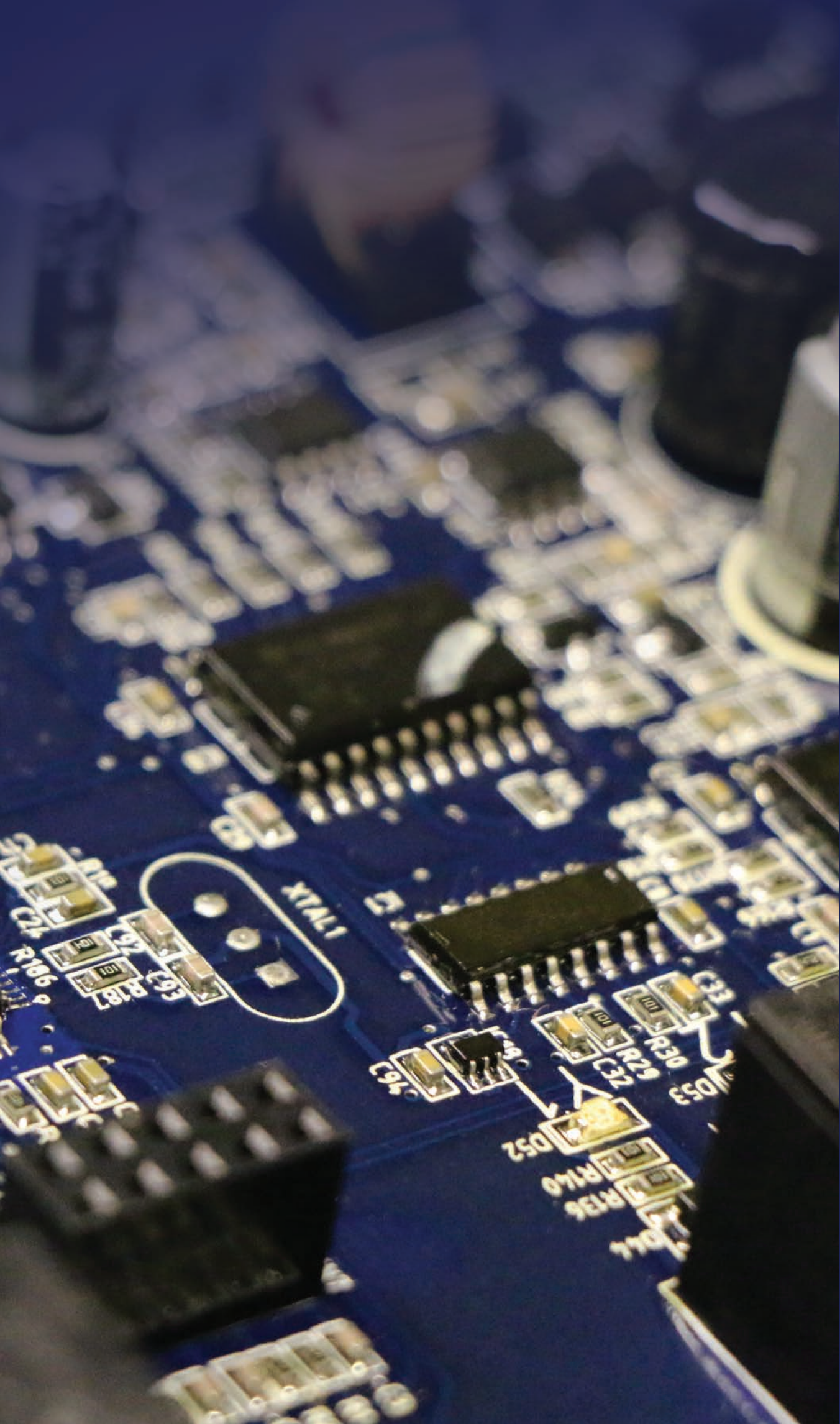

TÜMLEŞİK ASANSÖR KONTROL SİSTEMLERİ  
INTEGRATED ELEVATOR CONTROL SYSTEMS

## MT70 Asansör Kumanda Panosu MT70 Elevator Control Panel

WISE  
EASIM



MT70 DİŞLİSİZ MOTOR ASANSÖR KUMANDA PANOSU  
MT70 GEARBOX MOTOR SPEED CONTROL PANEL

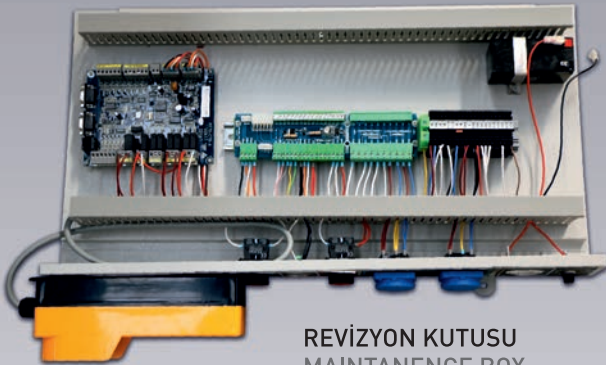

REVİZYON KUTUSU  
MAINTANENCE BOX



MT70 DİŞLİLİ MOTOR KUMANDA PANOSU  
MT70 GEARLESS MOTOR SPEED CONTROL PANEL

## ANDROID APP

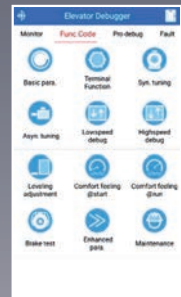
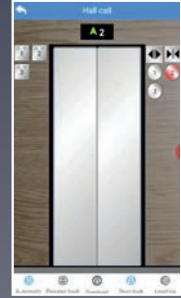

## - ÖZELLİKLER

- Uygulama Şekli  
Yeni asansörlerin kurulumunda ve eski asansörlerin revizyonlarında
- Motor kontrol modu  
Dişlisiz (senkron) makine ve Dişlili (Asenkron) makine
- Asansör Hızı  
4m/sn'ye kadar
- Durak sayısı  
48 durağa kadar
- Grup çalışma  
Dublex veya 8'li asansöre kadar
- Soketli hazır Kabin butonu tesisatı  
Hazır tesisat CAN-BUS haberleşmeli veya opsiyonel olarak paralel tesisat
- Kat tesisatı  
Hazır tesisat MOD-BUS haberleşmeli veya opsiyonel paralel tesisat
- Kapı Kontrolü  
Bağımsız olarak çalışabilen 2 kapı kontrolü
- Otomatik kata getirme  
1 Faz 220V AC Ups ile kurtarma
- Encoder seçenekleri  
Artımsal Encoder (5V TTL line driver veya 10-30V DC open collector)  
Mutlak Encoder (Endat ENC-1313/ERN-1387, Sin-COS veya UVW)
- Geri kaydırmayı önleme  
Herhangi bir yük sinyali olmadan otomatik olarak kabinin geri kaymasını engeller
- Şifreleme
- Büyük ekranlı el terminali
- Bluetooth modülü ile ANDROID telefonla ayarları yapılabilir

## - CHARACTERISTICS

- Application Type  
Installation of new lifts or replacement of old lifts
- Motor control mode  
Synchronous (gearless) machines or induction (geared) machines
- Speed range Up to 4 m/s
- Number of floors  
Up to 48 floors
- Group operation  
Dublex or Up to 8 lifts
- Ready-to-connect COP wire cables  
Standard CAN-BUS serial communication or optional parallel communication
- Landing wiring  
Standard MOD-BUS serial communication
- Door operation  
2 independently operated car entrances
- Emergency Rescue unit  
With 220V AC Power supply Input
- Encoder options  
Incremental encoders (5V TTL or 10-30V HTL)  
Absolute encoders (EnDat, SinCos or UVW)
- Rollback prevention at start  
Anti-rollback function (without any external load signal)
- Password
- Big screen keypad
- Bluetooth adjustment software

# WISEMONT HAZIR TESİSAT ASANSÖR KUMANDA SİSTEMİ

## Wisemont Ready Installation Lift Controller

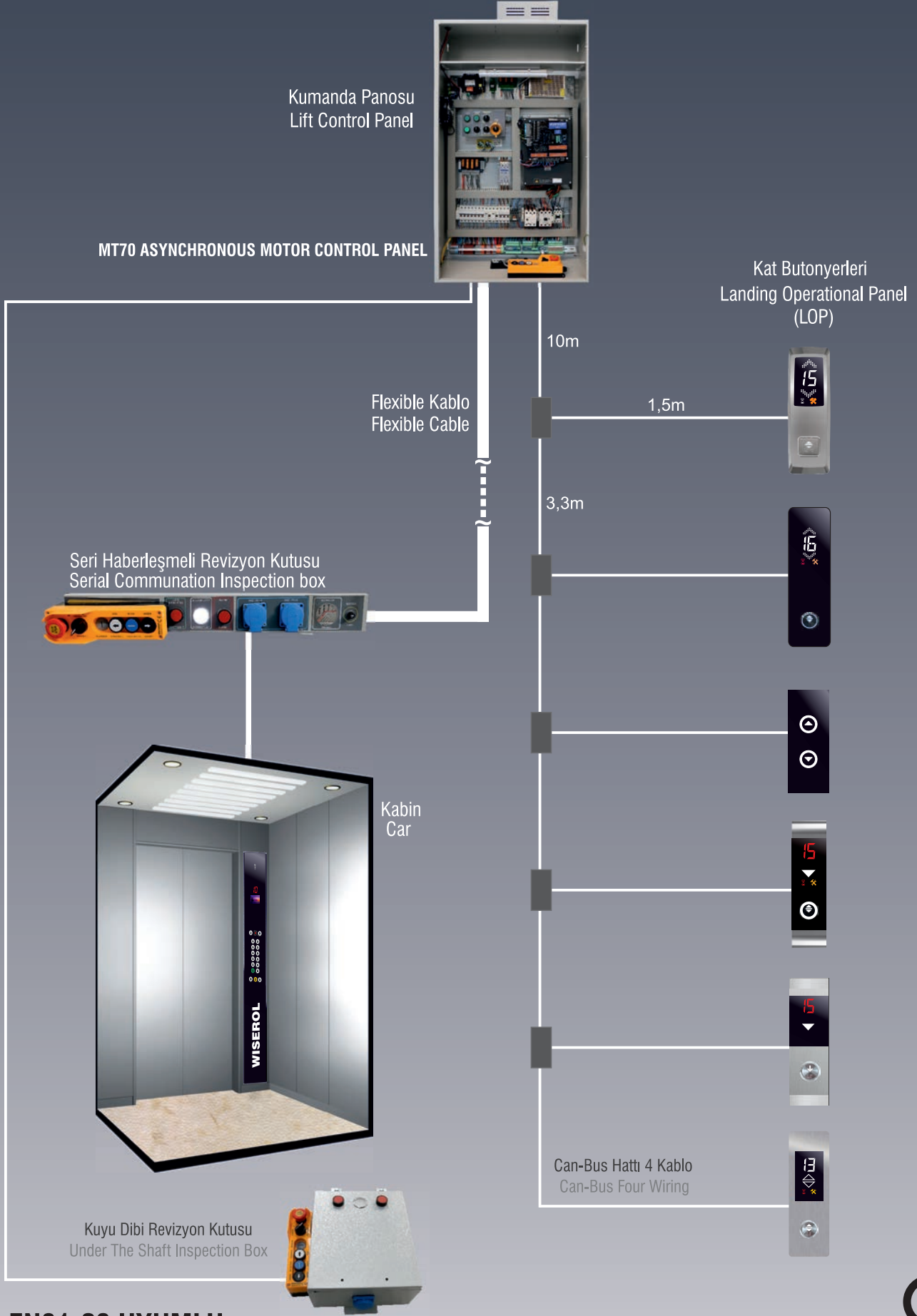

EN81-20 UYUMLU



## RNS Asansör Kumanda Panosu RNS Elevator Control Panel



RNS HIZ KUMANDA PANOSU  
RNS SPEED CONTROL PANEL

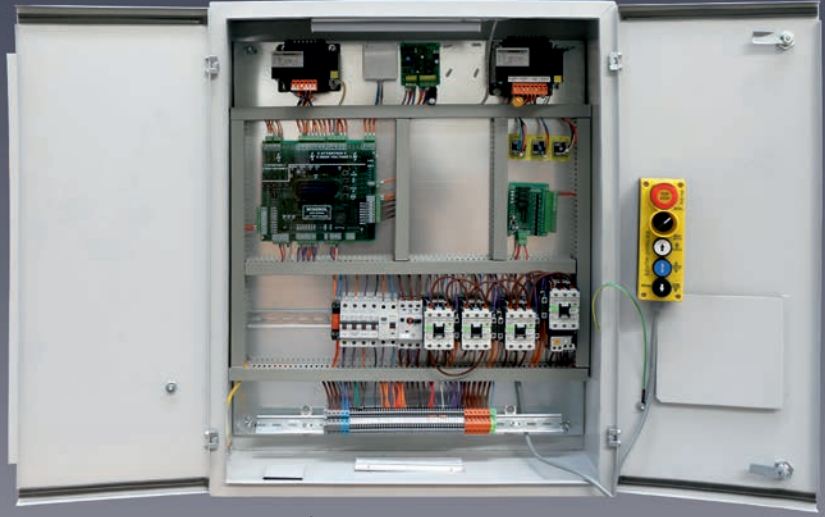

RNS ÇİFT HIZ KUMANDA PANOSU  
RNS DOUBLE SPEED CONTROL PANEL

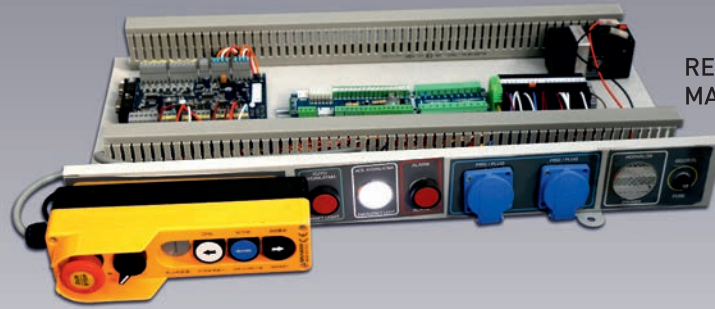

REVİZYON KUTUSU  
MAINTENANCE BOX

### – ÖZELLİKLER

- Uygulama Şekli  
Hız Kontrollü, Çift Hızlı, Hidrolik
- Motor kontrol modu  
Dişlisiz (senkron) makine ve Dişlili (Asenkron) makine
- Asansör Hızı  
1,6m/sn'ye kadar
- Durak sayısı  
16 durağa kadar
- Soketli hazır Kabin butonu tesisatı  
Hazır tesisat CAN-BUS haberleşmeli veya paralel tesisat
- Kat tesisatı  
Hazır tesisat MOD-BUS haberleşmeli veya opsiyonel paralel tesisat
- Kapı Kontrolü  
Bağımsız olarak çalışabilen 2 kapı kontrollü
- Otomatik kata getirme  
3 Faz 60V DC 4 Akü ile kurtarma
- Encoder seçenekleri  
Artımsal Encoder (5V TTL line driver veya 10-30V DC open collector)  
Mutlak Encoder (Endat ENC-1313/ERN-1387, Sin-COS veya UVW)
- Geri kaydırmayı önleme  
Herhangi bir yük sinyali olmadan otomatik olarak kabinin geri kaymasını engeller

### – CHARACTERISTICS

- Application Type  
Speed Control, Double Speed, Hydrolic
- Motor control mode  
Synchronous (gearless) machines or induction (geared) machines
- Speed range Up to 1,6 m/s
- Number of floors  
Up to 16 Stop
- Ready-to-connect COP wire cables  
Standard CAN-BUS serial communication or parallel communication
- Landing wiring  
Standard MOD-BUS serial communication
- Door operation  
2 independently operated car entrances
- Emergency Rescue unit
- Encoder options  
Incremental encoders (5V TTL or 10-30V HTL)  
Absolute encoders (EnDat, SinCos or UVW)
- Rollback prevention at start  
Anti-rollback function (without any external load signal)

### Deprem Sensörü Earthquake Sensor



\* Operating Voltage : 12V DC  
\* X Axis Reaction Time : 3 sn  
\* Z Axis Reaction Time : 3 sn  
\* Seismic Category : 3

\* Çalışma Voltajı : 12V DC  
\* X Eksenli Reaksiyon Süresi : 3 sn  
\* Z eksenli Reaksiyon Süresi : 3 sn  
\* Sismik Kategorisi : 3



*Güvenliğiniz bizim için önemli...*

*Your safety is important to us...*

### Fotosel Merkezi Photocell Center



### Fotosel Photocell



Alıcı Ve Verici Modül Sayısı / Rx and Tx Module : 18 İnfrared Led  
Çalışma Mesafesi / Running Distance : 0-2500mm  
Besleme Gerilimi / Power Supply : 220v-ac  
Çıkış / Exit : no-nc Relay Contac  
İkaz / Warning : Buzzer  
Dikey Tolerans / Vertical Tolerance : 10mm ,10 Deg.  
Tepki Süresi / Response Time : 50. Msn.  
Ölçüler / Dimensions : 30mm X 11mm X 1950mm  
Aydınlık Bağışıklığı / Luminous Immunity : 100.000 Lüks  
Kablo / Cable : %80 Dolulukta Bakır Ekran Ve Ekstra Flex Yapı



IR-18



Dünya'nın Her Yerine İhracat!  
Export to all over the world!



## WISEROL

ELİT ELEKTRONİK VE ASANSÖR SAN. TİC. LTD. ŞTİ.

SATIŞ OFİSİ / SALES OFFICE  
Yukarı Dudullu Şenol Sk. No: 16 PK: 34775  
Ümraniye / İstanbul / TÜRKİYE  
TEL: +90 216 365 00 33  
FAX: +90 216 365 00 32

FABRİKA / FACTORY  
Organize Sanayi Bölgesi 8. Cadde  
No:71 Kayseri / TÜRKİYE  
TEL : +90 352 322 30 00 - 01 02 03  
FAX : +90 352 322 30 04

[www.wiserol.com.tr](http://www.wiserol.com.tr) | [wiserol@wiserol.com](mailto:wiserol@wiserol.com) | [facebook.com/Wiserol Elit Elektronik](https://facebook.com/Wiserol%20Elit%20Elektronik)